

# Easy Step-By-Step Instructions

## Featuring Quickfit-Expando-6 Connectors

### for W/S-250 Tabletop Lectern Assembly

The Tabletop Lectern is designed for easy assembly. If you have any questions about assembling or using your new sound system, or if you want more information about accessories, call AmpliVox's customer service line.

The lectern is carefully packed to minimize shipping damage. If your unit was damaged in shipping call our toll-free customer service line or visit our web site at <http://www.ampli.com>

**1-800-267-5486**



#### Packing List:

- Reading table top
- Bottom panel
- 2 Side panels, left and right
- Front/speaker panel
- Black speaker grille(S-250)
- Hand-held mic (S-250)
- Mic cable (S-250)
- Gooseneck w/mic holder (S-250)
- Amplifier (S-250)

#### Hardware:

- 12 Quickfit-Expando-6 Connectors pre-installed
- 12 Push-in Quickfit-6 Expanding dowels

#### Tools Needed:

- Phillips Screwdriver - for 1/2 turn of pre-inserted Quickfit-Expando-6 Connectors

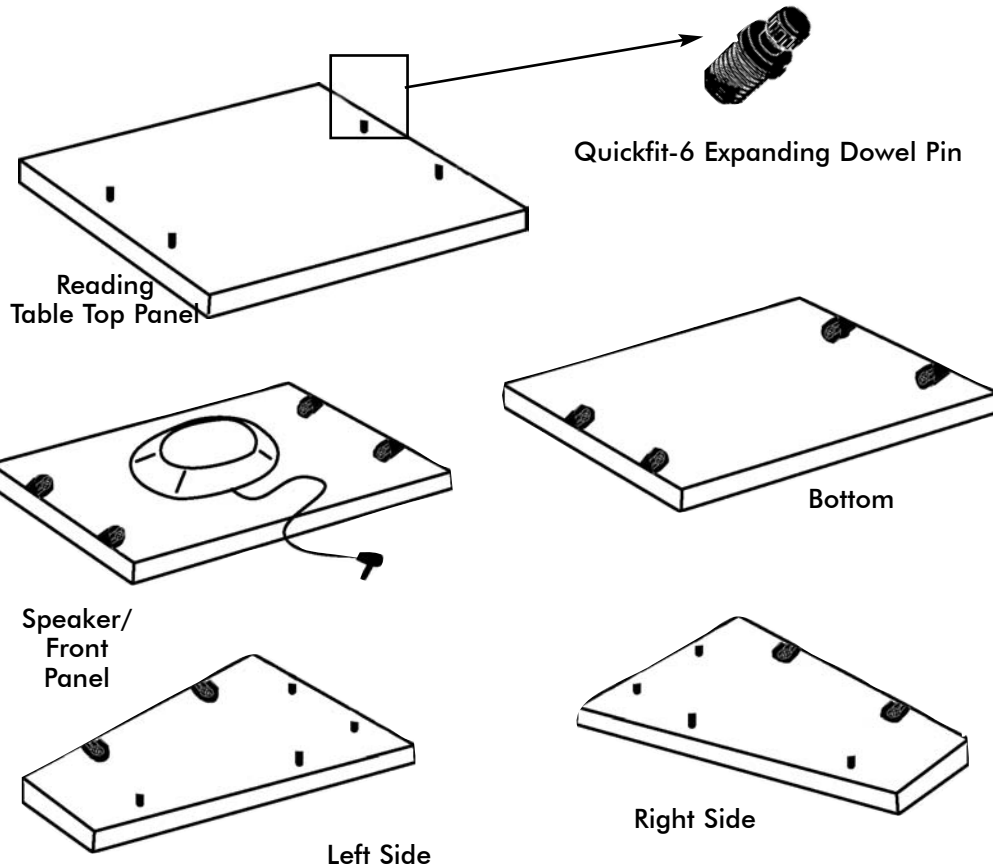

**1. Unpack all the pieces.** Be sure to save the packing and the box in case you need to return the lectern for any reason. Check that you have all the pieces and that they are not damaged.

**2. Insert the dowel pins.** With your thumb(or use phillips screwdriver to ease insertion), push the dowel pins into the holes in the 2 sides and the top. Make sure the plastic collar is flush with the wood surface.

**3. Inspect the Pre-installed Quickfit Expando-6 Connectors.** Check the Top, Speaker/Front, Left and Right Side Panels to insure that the flat edge on the connector is facing the outer edge of the board. Use a phillips screwdriver to rotate them, if needed.

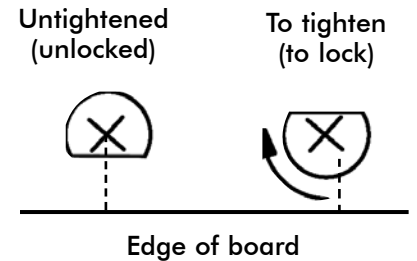

#### How the Quickfit-Expando-6 Connectors work.

**Do not over tighten the connectors.** They will break if turned too far. Turn only 1/2 turn clockwise to lock. The steel Quickfit-6 expanding dowels and the Quickfit-Expando-6-Connectors lock together for easy assembly.

Turn counterclockwise to unlock

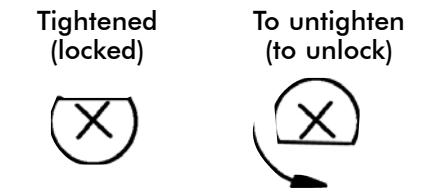

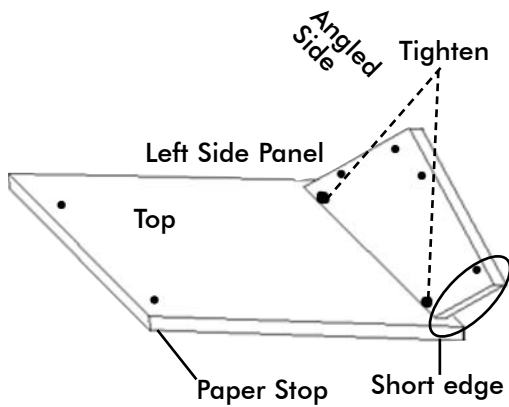

**4. Attach the left side.** Place Top panel on protected flat surface with dowel pins facing up. Place the left side panel with the finished edge facing up onto the top panel and slide side panel until its dowel pins are completely inserted into the Quick-fit connectors as far as they can go. The short edge of the side panel should be towards the edge of the Top panel that has the paper stop. Use a phillips screwdriver to tighten the 2 Quick-fit Connectors. Turn only 1/2 turn clockwise. **Over tightening will break the connectors!!**

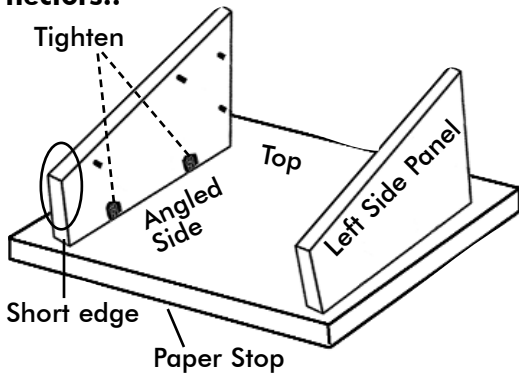

**5. Attach the right side panel.** Attach the right side panel using the same instructions as the left side panel to the top panel and tighten the 2 Quick-fit Connectors.

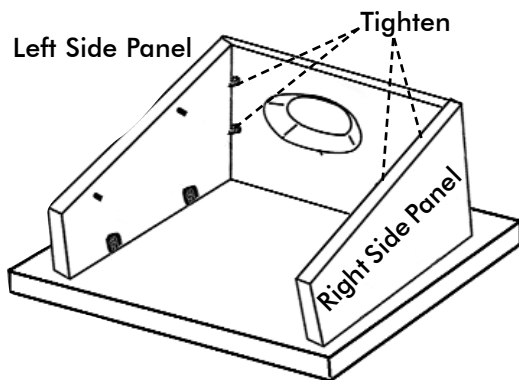

**6. Attach the front/speaker panel.** Make sure the finished edge of the speaker/front panel is facing up towards you. Slide speaker/front panel until the dowel pins of the right and left side panels are completely inserted into the Quick-fit connectors of the speaker/front panel. Tighten the 4 Quickfit Connectors in speaker/front panel 1/2 turn.

**7. Attach the bottom.** Carefully pick up and place the Top, Right and Left side panel assembly on its side with the Top panel facing opposite of you. Insert the Bottom Panel under the pins on the Right and Left side panels by sliding the bottom panel under pins of the sides. Now slide the bottom panel until the dowel pins of the side panels are completely inserted into the Quick-fit connectors of the bottom panel. Tighten the 4 Quickfit Connectors on the bottom panel 1/2 turn.

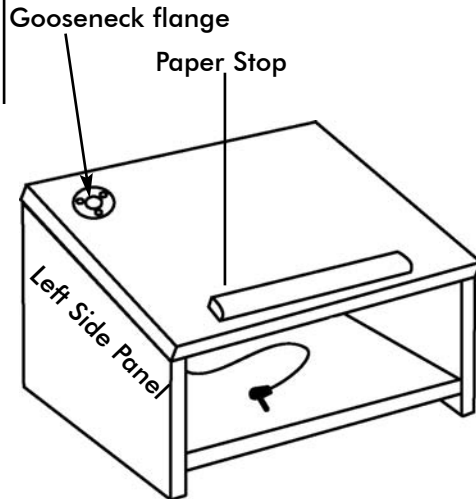

**8. Carefully turn over lectern** After tightening Expando Connectors on the bottom of the lectern, **Carefully** pick up and turn over lectern so that the Paper Stop is facing up.(see illustration above)

**S-250 ONLY**

**9. Install the batteries** in the amp. Refer to the amp instruction sheet for battery installation information.

**10. Attach the gooseneck.** Screw the gooseneck with mic holder onto the gooseneck flange. Insert the mic cord into the mic base. Place the mic into the mic holder; insert the mic plug into the "dynamic" microphone jack.

**11. Plug-in the speaker.** Plug the speaker cord into either the right or left amp jack. If you have a second external speaker, connect its 1/4" plug into the Speaker- R jack Set the amplifier inside the lectern.

**12. Attach the speaker grille** by pressing its posts into the holes on the front of the lectern.

Refer to the S-805A amplifier operating instructions for information about the amp controls.

If you purchased any optional accessories such as a wireless kit, lapel mic, International AC Adapter/Recharger, extra speakers, tripods, etc. refer to the instructions packed with them for installation and usage information.

Your Tabletop Lectern is now complete. Thousands of AmpliVox sound products have been in use since we first began shipping in 1961. We hope you enjoy many years of use from your new Tabletop Lectern.

If you have any questions or comments, call customer service line.

**1-800-267-5486**

## Optional Accessories

### Batteries

S-1430	Alkaline D-Cell Batteries; set of 10 .....	\$26.00
S-1465	NiCad battery pack; 4.3 amp hours.....	\$165.00

### Power Supply

S-1460	International AC Adapter/Recharger;110/220 volts;50/60 Hz.	\$109.00
--------	--	----------

### Wireless Kits

S-1600	Wireless Lapel Mic Kit .....	\$308.00
S-1610	Wireless Headset Mic Kit .....	\$374.00
S-1612	Wireless Lapel/Headset Mic Kit .....	\$374.00
S-1620	Wireless Hand-Held Mic Kit .....	\$374.00

### Microphones

S-2030	Lapel Mic; with 12 ft. extension .....	\$55.00
S-2040	Headset Mic; with 12 ft. extension .....	\$121.00
S-2030A	Hand-Held Mic and Cable.....	\$99.00
S-1720	Mic Extension Cord; 25-ft.....	\$65.00

### Extra Speaker & Tripod

S-1201	Compact Companion Speaker; black high pressure laminate ..	\$209.00
S-1090	Tripod for speaker .....	\$188.00

### Light

S-1100	AC Reading Light; clip-on .....	\$55.00
--------	---------------------------------	---------

### Media Cart Base

S-260	Combines with Tabletop Lectern to form a full-size lectern or use separately for slide projector, etc. ....	\$197.00
-------	---	----------

Prices are subject to change without notice