



Models BETA 53™, BETA 54™ User Guide

Subminiature Condenser Headworn Microphones



BETA 53



BETA 54

Shure models BETA 53™ and BETA 54™ are subminiature, electret condenser head worn microphones. They provide uncompromised sound quality and reliability with minimal visibility in applications such as broadcast, theater, and touring. Despite their small size, each microphone's condenser element delivers full, clear, and natural reproduction of speech and vocals. The microphone features a durable, low-profile wire frame headband which is fully adjustable for stability and comfort. A plastic carrying case protects the microphone and its accessories.

BETA 53 Features

- Omnidirectional polar pattern for minimal handling noise and flexible microphone placement
- Extended, flat frequency response provides accurate speech and vocal reproduction
- Two interchangeable protective caps for response shaping
- Foam windscreens minimize breath noise and “popping”
- Available with an in-line preamp or with a TA4F connector for wireless applications
- Choice of black or tan finish to suit your performance environment

BETA 54 Features

- Supercardioid polar pattern provides maximum gain-before-feedback and ambient rejection
- Extended frequency response tailored for vocal performances
- Able to handle extremely high sound pressure levels (SPL)
- Snap-fit foam windscreens stay in place during intensive movement
- Available with an in-line preamp or with a TA4F connector for wireless applications
- Choice of black or tan finish to suit your performance environment

Available Models

BETA 53 MODELS

- Omnidirectional
- For broadcast and stage

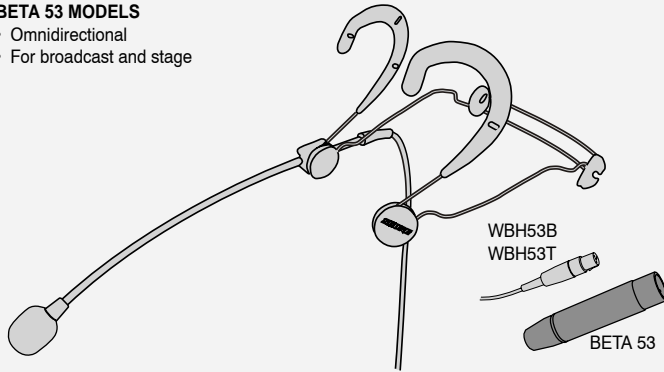

BETA 53	<ul style="list-style-type: none"> • Black finish • Detachable in-line preamp for wired applications • Requires phantom power
WBH53B	<ul style="list-style-type: none"> • Black finish • TA4F connector for wireless applications
WBH53T	<ul style="list-style-type: none"> • Tan finish • TA4F connector for wireless applications

All models include: microphone and headband (1 each), foam windscreens (2), standard protective cap (2), filtered protective cap (2), swiveling lapel clip (1), boom holder (2), logo pad (1) and plastic carrying case (1).

BETA 54 MODELS

- Supercardioid
- For stage and vocal performance

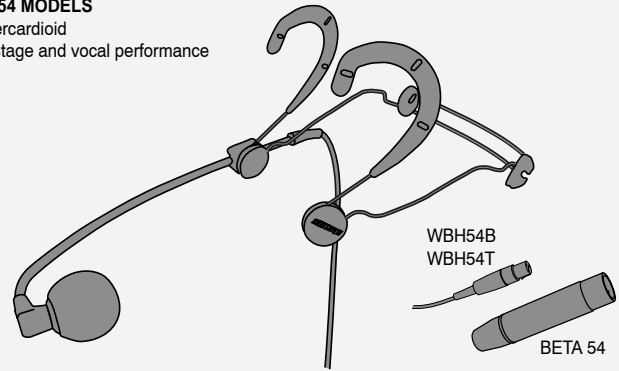

BETA 54	<ul style="list-style-type: none"> • Black finish • Detachable in-line preamp for wired applications • Requires phantom power
WBH54B	<ul style="list-style-type: none"> • Black finish • TA4F connector for wireless applications
WBH54T	<ul style="list-style-type: none"> • Tan finish • TA4F connector for wireless applications

All models include: microphone and headband (1 each), snap-fit foam windscreens (2), standard protective cap (2), swiveling lapel clip (1), boom holder (2), logo pad (1) and plastic carrying case (1).

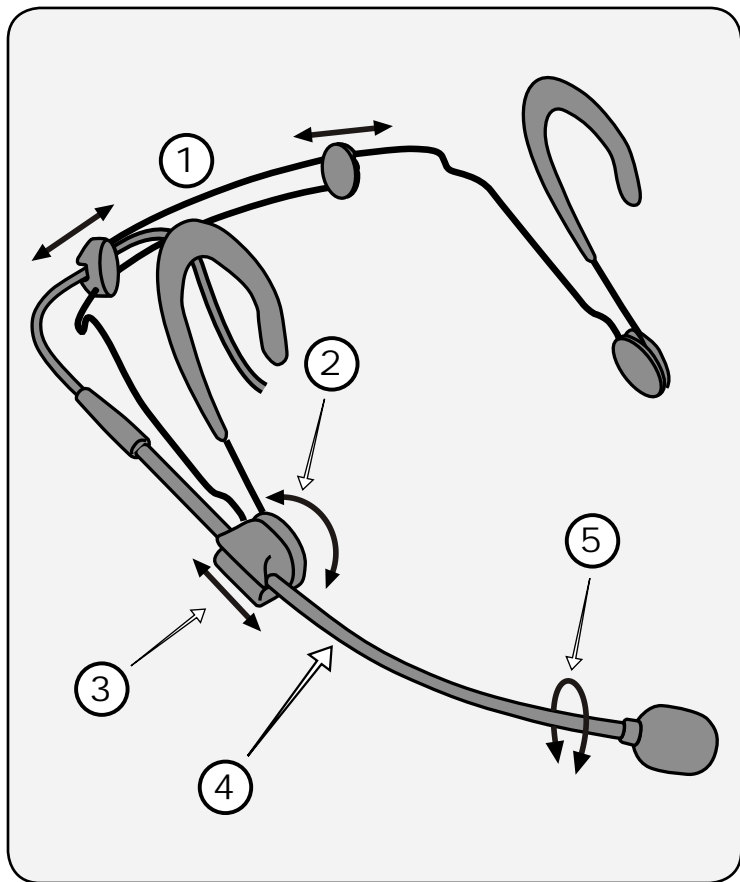

①	Adjust headband width
②	Adjust boom height
③	Adjust boom length
④	Do not attempt to bend the microphone boom!
⑤	"Roll" the boom for subtle adjustments of microphone position

Using the Windscreens and Protective Caps

- Foam windscreens may be cleaned with soap and water.
- For the best sound quality, replace damaged or clogged protective caps and windscreens.

BETA 53

Standard protective cap

- Gold mesh
- No attenuation

Filtered protective cap

- Silver mesh
- Attenuates high frequencies (see page 52)

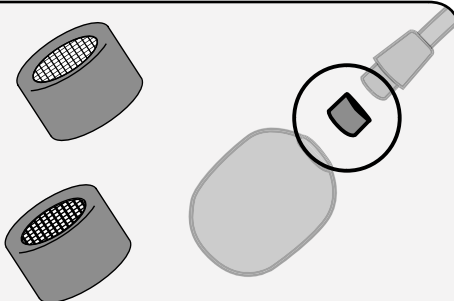

BETA 54

Grip the internal frame of the windscreen firmly when connecting or removing. **Do not pull on the foam itself.**

- To connect, push the windscreen until it snaps into place over the cartridge.
- To remove, pull the windscreen directly off of the cartridge.

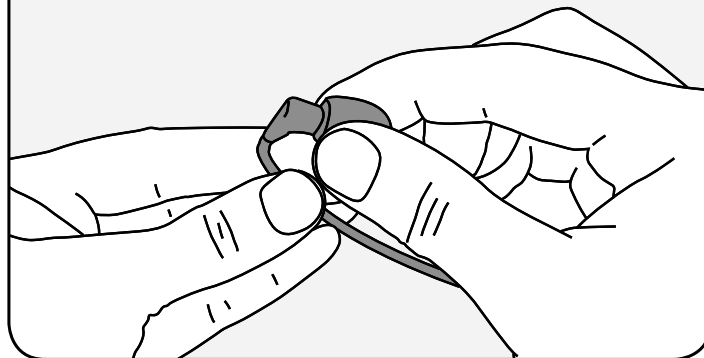

Always use the BETA 54 with the **standard** protective cap **only**. Using the microphone with no cap, or with the filtered cap, will degrade sound quality and alter the microphone's polar pattern.

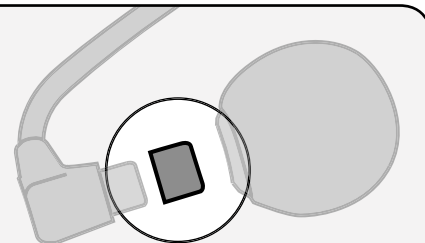

Wearing the BETA 53 and BETA 54

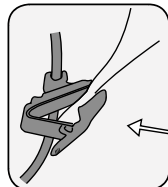
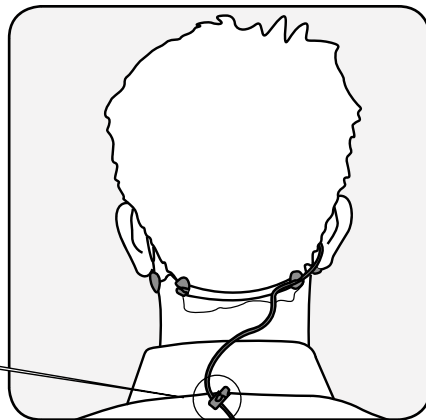
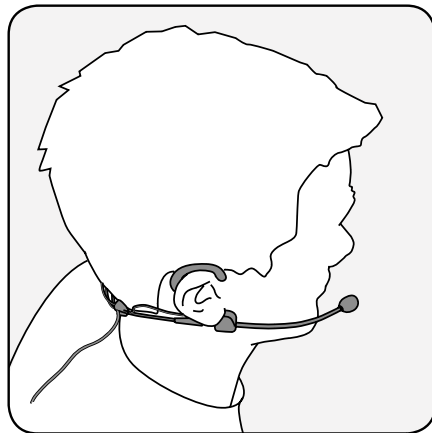
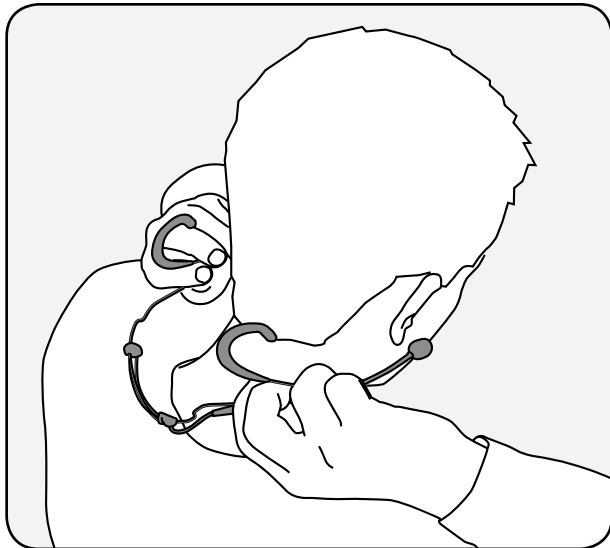
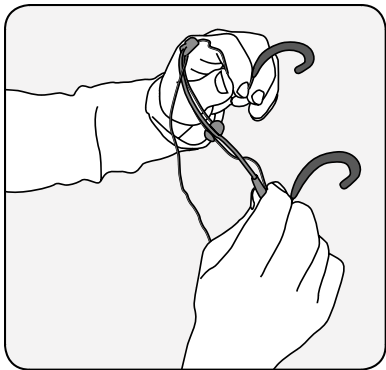

Positioning the Microphone

BETA 53

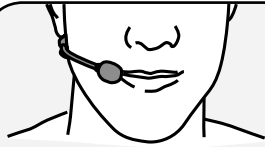

- Position the omnidirectional BETA 53 microphone near the corner of the mouth
- If necessary, roll the boom to avoid contact with skin and facial hair

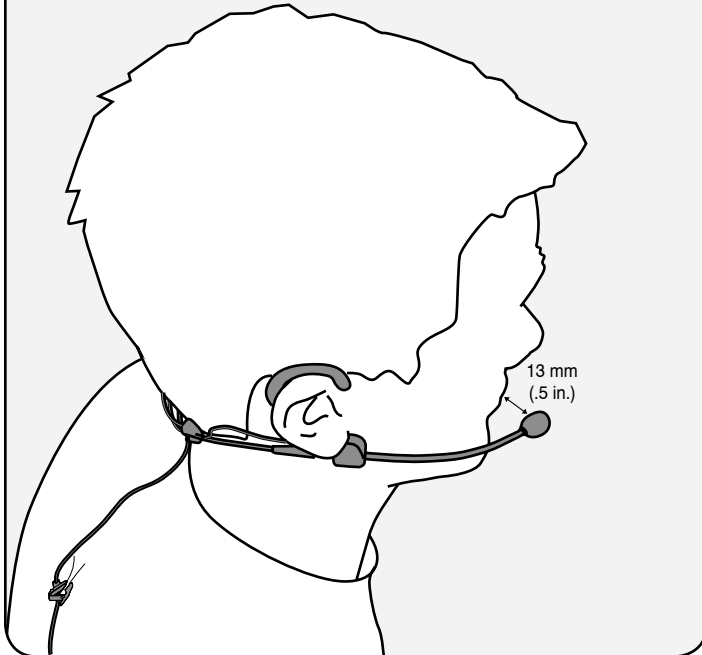

BETA 54

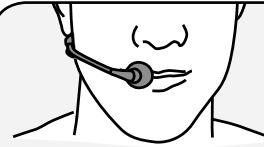

- Point the unidirectional BETA 54 microphone at the corner of the mouth



Wearing the Microphone on Either Side

All models may be worn with the microphone on the left or the right.

- Carefully detach the boom holder (1), logo pad (2), and microphone cable (3) from the headband.

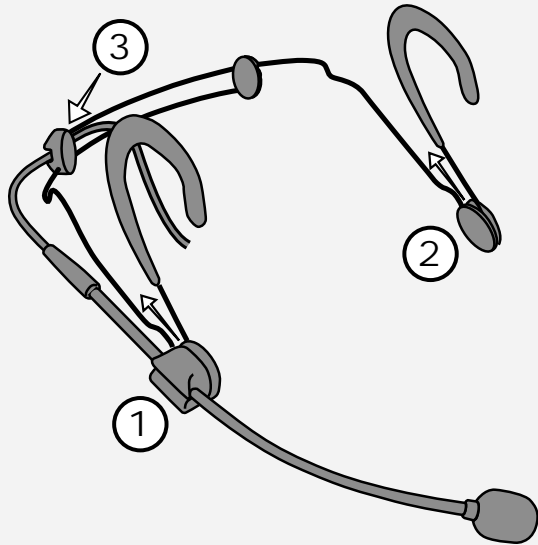

- Reattach the boom holder to the opposite side of the wire frame (4).
- Reattach the logo pad (5) and microphone cable (6).

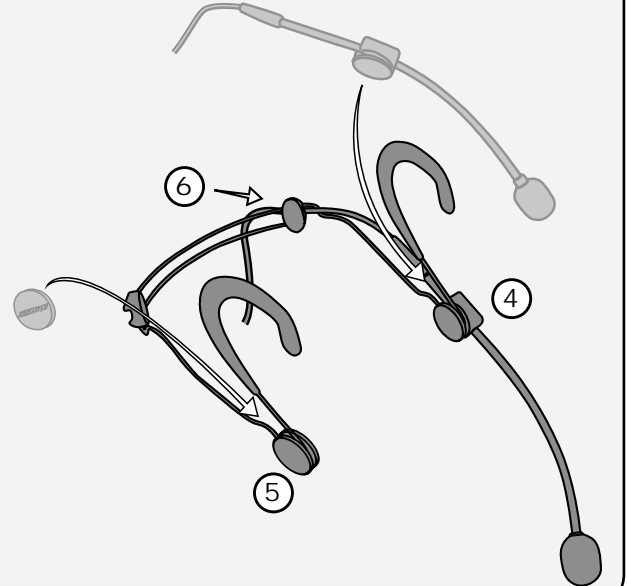

BETA 53 Replacement Parts and Accessories

	<i>Component</i>	<i>Black</i>	<i>Tan</i>
①	Foam Windscreen (5 pieces)	RPM304	RPM306
②	Standard Protective Cap* (gold mesh) (5 pieces)	RPM208	RPM212
	Filtered Protective Cap* (silver mesh) (5 pieces)	RPM220	RPM214
③	Microphone/Boom Assembly with TA4F Connector (1 piece)	RPM132	RPM134
④	Swiveling Lapel Clip (5 pieces)	RPM510	RPM512
⑤	Boom Holder and Logo Pad (2 each)	RPM570	RPM580
⑥	Headband (1 piece, with boom holder and logo pad)	RPM550	RPM560
⑦	4-Pin Mini Connector (TA4F) (1 piece)	WA330**	
⑧	In-Line Preamp (1 piece)	RPM626**	
Not Pictured	Battery Powered Preamp (1 piece)	MX1BP**	
Not Pictured	Phantom Power Supply (1 piece)	PS1A**	

*See the frequency response curve on page 52

**Available in black only

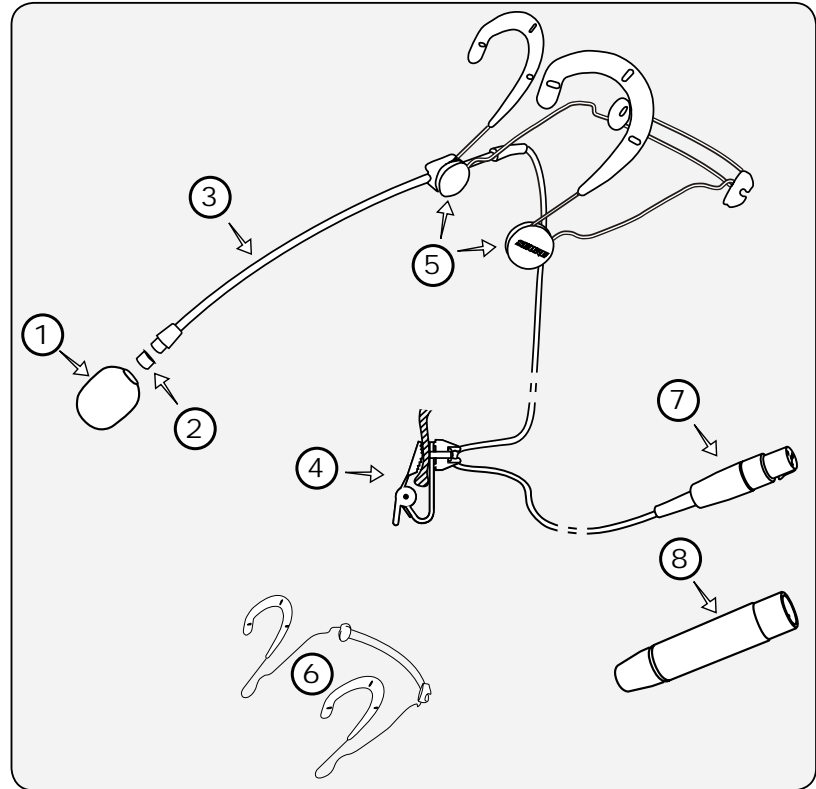

	<i>Component</i>	<i>Black</i>	<i>Tan</i>
①	Microphone/Boom Assembly with TA4F Connector (1 piece)	RPM646	RPM648
②	Standard Protective Cap (gold mesh) (5 pieces)	RPM208	RPM212
③	Snap-fit Foam Windscreen (4 pieces)	RPM316	RPM318
④	Swiveling Lapel Clip (5 pieces)	RPM510	RPM512
⑤	Boom Holder and Logo Pad (2 each)	RPM570	RPM580
⑥	Headband (1 piece, with boom holder and logo pad)	RPM550	RPM560
⑦	4-Pin Mini Connector (TA4F) (1 piece)	WA330*	
⑧	In-Line Preamp (1 piece)	RPM626*	
Not Pictured	Battery Powered Preamp (1 piece)	MX1BP*	
Not Pictured	Phantom Power Supply (1 piece)	PS1A*	

*Available in black only

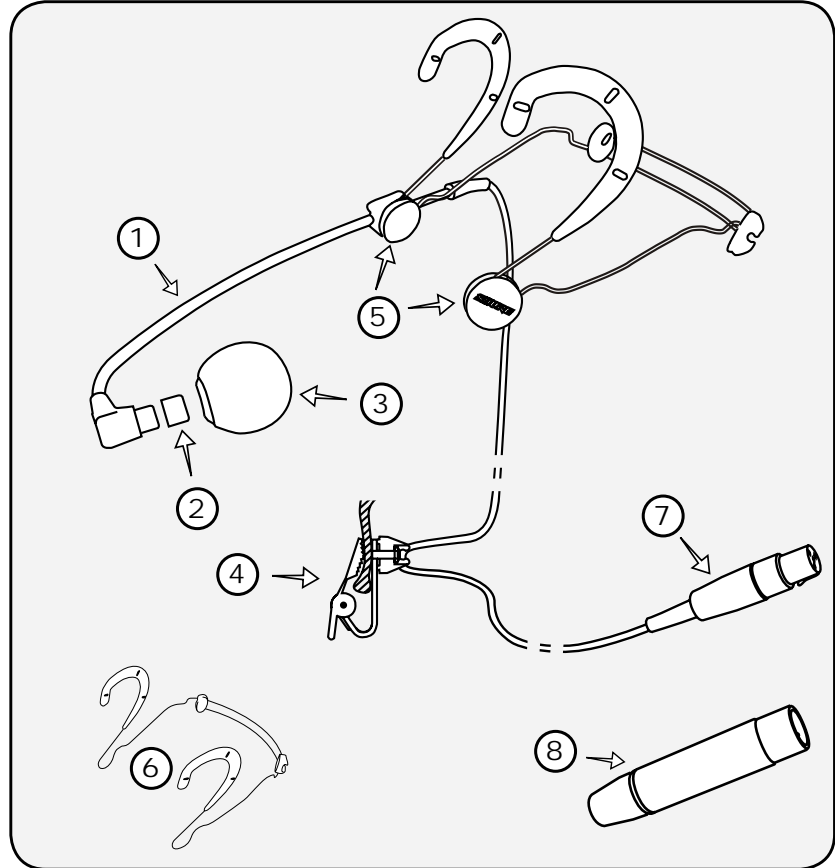

Specifications

Specification	BETA 53		BETA 54	
	Wired	Wireless	Wired	Wireless
Type	Condenser (electret bias)		Condenser (electret bias)	
Frequency Response	20Hz to 20KHz (see page 52)		50Hz to 20KHz (see page 52)	
Polar Pattern	Omnidirectional (see page 52)		Supercardioid (see page 52)	
Output Noise (equivalent dB SPL, A-weighted)	39.0 dB typical; 42.0 dB maximum		39.0 dB typical; 42.0 dB maximum	
Signal-to-Noise Ratio	55 dB at 94 dB SPL		55.0 dB at 94 dB SPL	
Recommended Minimum Input Impedance	>1 kΩ	20 kΩ	>1 kΩ	20 kΩ
Preamp Output Impedance	136Ω		136Ω	
Output Level, open circuit, ref. 1v/Pa at 1 kHz	-50.0 ± 3.0dB 3.16mV	-54.0 ± 3.0dB 2.0mV	-52.0 ± 3.0dB 2.51mV	-56.0 ± 3.0dB 1.58mV
Maximum Sound Pressure Level	147 dB SPL at 1% THD/1 kΩ load	142 dB SPL at 1% THD/20 kΩ load	149 dB SPL at 1% THD/1 kΩ load	144 dB SPL at 1% THD/20 kΩ load
Dynamic Range	108 dB (max. SPL with 1k load, minus typical A-wt. noise)	103 dB (max. SPL with 20k load, minus typical A-wt. noise)	110 dB (max. SPL with 1k load, minus typical A-wt. noise)	105 dB (max. SPL with 20k load, minus typical A-wt. noise)
Current Drain	4.6 mA (preamp and microphone)	60-130 μA (microphone only)	4.6 mA (preamp and microphone)	60-130 μA (microphone only)
Output Polarity Positive pressure on the diaphragm produces a positive voltage at:	Pin 2 relative to pin 3 at the output connector of the preamp	Pin 3 (black lead) relative to pin 1 (shield lead) at the output connector of the microphone	Pin 2 relative to pin 3 at the output connector of the preamp	Pin 3 (black lead) relative to pin 1 (shield lead) at the output connector of the microphone
Power Requirements	Phantom power; 11 to 52 Vdc positive on pins 2 and 3, return on pin 1 (ground)	+5 Vdc on pin 2, return on pin 1 (ground)	Phantom power; 11 to 52 Vdc positive on pins 2 and 3, return on pin 1 (ground)	+5 Vdc on pin 2, return on pin 1 (ground)
Net Weight	135.35 g (4.75 oz.) microphone and in-line preamp	35.35 g (1.25 oz.) microphone only	135.35 g (4.75 oz.) microphone and in-line preamp	35.35 g (1.25 oz.) microphone only
Cable	1.5 m (5 ft.), small-diameter, shielded, with mini 4-pin connector (TA4F)			

Polar Patterns and Frequency Response

BETA 53

BETA 54

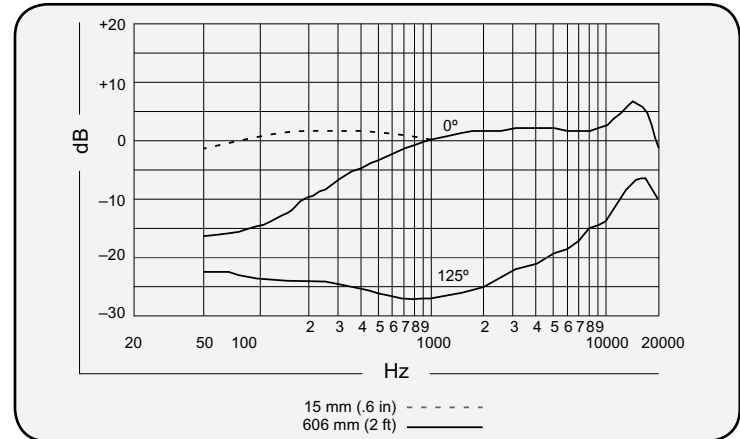
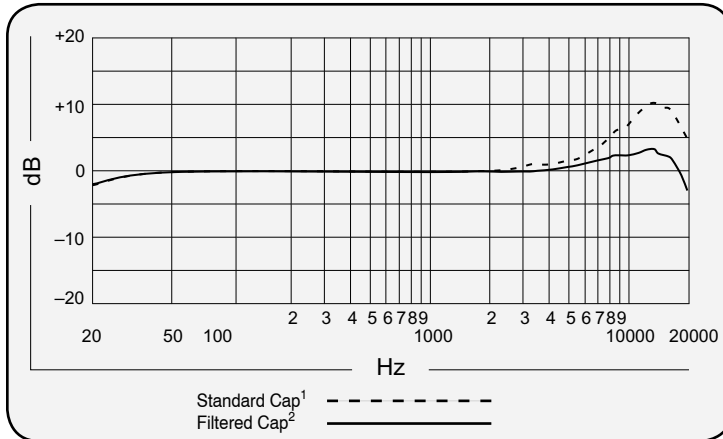
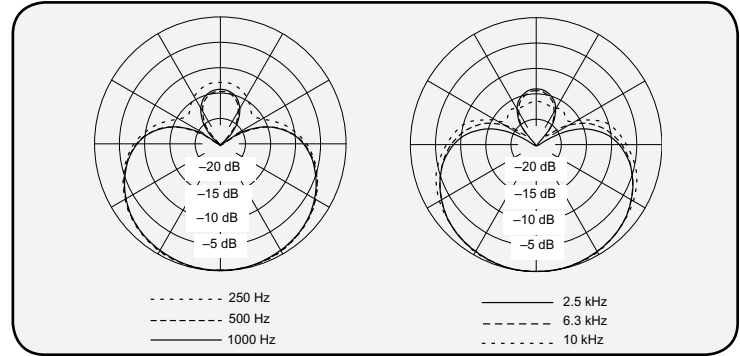
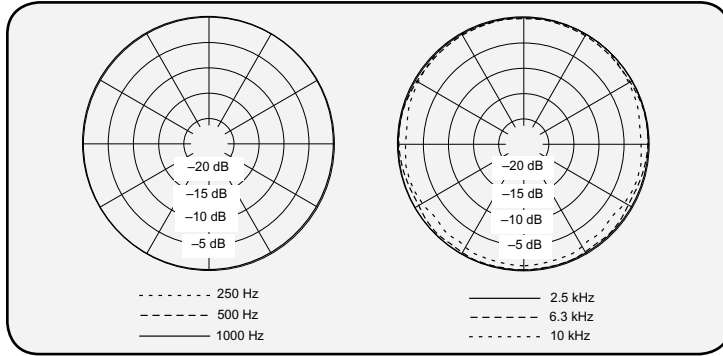

¹Capuchon standard
²Capuchon à filtre

¹Standardmäßige Kappe
²Gefilterte Kappe

¹Tapa estándar
²Tapa con filtro

¹Cappuccio standard
²Cappuccio dotato di filtro

Wiring and Certification

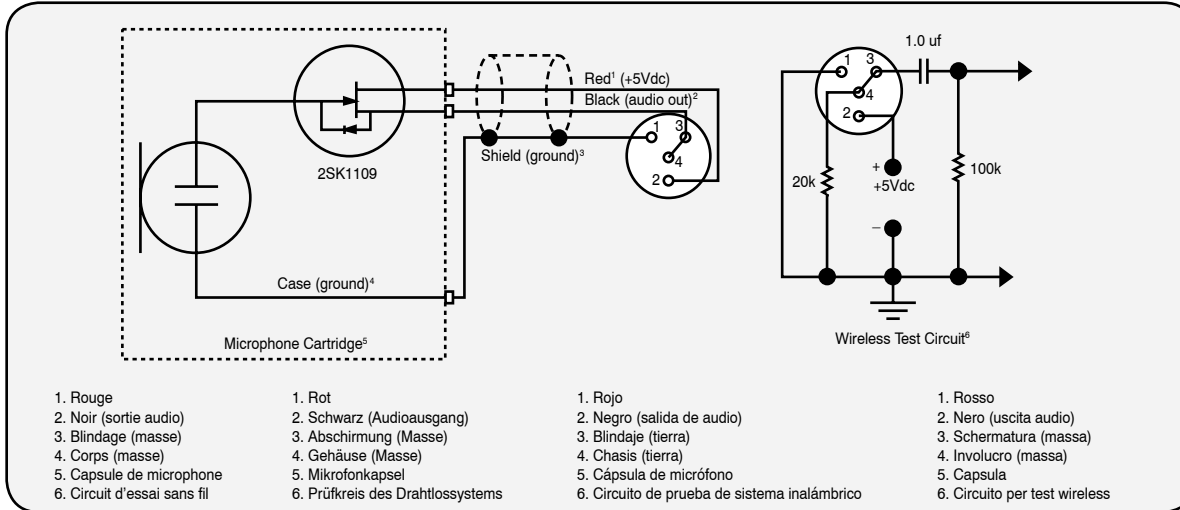

Eligible to bear CE marking. Conforms to European EMC directive 89/336/EEC. Meets applicable tests and performance criteria in European EMC Standard EN 55103 (1996) parts 1 and 2, for residential (E1) and light industrial (E2) environments. Meets applicable test and performance criteria in European wireless microphone EMC standard EN 301 489 Parts 1 and 9.

Autorisé à porter la marque CE. Conforme à la directive CEM européenne 89/336/CEE. Conforme aux critères applicables de test et de performances de la norme CEM européenne EN 55103 (1996) parties 1 et 2 pour les environnements résidentiels (E1) et d'industrie légère (E2). Conforme aux critères applicables de test et de performances de la norme CEM européenne EN 301 489 Parties 1 et 9.

Zur CE-Kennzeichnung berechtigt. Entspricht der EU-Richtlinie über elektromagnetische Verträglichkeit 89/336/EWG. Erfüllt die Prüfungs- und Leistungskriterien der europäischen Norm EN 55103 (1996) für elektromagnetische Verträglichkeit, Teil 1 und 2, für Wohngebiete (E1) und Gewerbegebiete (E2). Erfüllt die Prüfungs- und Leistungskriterien der europäischen Norm EN 301 489 Teil 1 und 9.

Califica para portar la marca CE. Cumple la directiva europea 89/336/EEC de compatibilidad electromagnética. Se ajusta a los criterios correspondientes de verificación y funcionamiento establecidos en la norma europea de compatibilidad electromagnética EN 55103 (1996), partes 1 y 2, para zonas residenciales (E1) y zonas de industria ligera (E2). Se ajusta a los criterios correspondientes de verificación y funcionamiento establecidos en la norma europea de compatibilidad electromagnética EN 301 489 Partes 1 y 9.

Contrassegnabile con il marchio CE. Conforme alla direttiva 89/336/CEE della Comunità Europea, relativa alla compatibilità elettromagnetica. Soddisfa i criteri di prestazione e le verifiche pertinenti nella regolamentazione europea sulla compatibilità elettromagnetica a norma EN 55103 (1996) parti 1 e 2, relativa ad ambienti domestici (E1) ed industriali leggeri (E2). Soddisfa i criteri di prestazione e le verifiche pertinenti nella regolamentazione europea sulla compatibilità elettromagnetica a norma EN 301 489 Parti 1 e 9.



Patent Notice: Patent Des. 451,902

©2002, Shure Incorporated
27D3115 (BK)

The SHURE logo is rendered in a bold, blue, sans-serif font. The letters are thick and closely spaced, with a slight shadow effect that gives it a three-dimensional appearance. The 'S' and 'H' are particularly prominent due to their size and the way they connect to the other letters.

SHURE Incorporated Web Address: <http://www.shure.com>
5800 W. Touhy Avenue, Niles, IL 60714-4608, U.S.A.
Phone: 800-257-4873 Fax: 847-866-2279
In Europe, Phone: 49-7131-72140 Fax: 49-7131-721414
In Asia, Phone: 852-2893-4290 Fax: 852-2893-4055
Elsewhere, Phone: 847-866-2200 Fax: 847-866-2585