

EX-S8 TWO-WAY COAXIAL 8-INCH
SURFACE MOUNT LOUDSPEAKER



FEATURES

- Exceptional audio clarity with small footprint and attractive styling
- Uniform coverage from coaxially mounted HF/LF drivers
- 5-position switch selects 70V/100V taps or low impedance bypass
- ETL listed to comply with UL 1480A, CSA 62368-1, CE marked, and RoHS compliant
- EN54-24 certified

APPLICATIONS

DISTRIBUTED
Bars and Restaurants · Hotels · Casinos
Shopping Malls · Health and Fitness Clubs
Houses of Worship · Presentation Spaces
Sports Facilities · Outdoor Entertainment
Exhibit Halls · Amusement and Theme
Parks

DESCRIPTION

The Desono™ EX surface mount loudspeakers provide excellent acoustic performance in elegant, attractive aesthetics for a diverse range of indoor and outdoor distributed applications. EX Series includes three two-way, full range models and one matching-enclosure subwoofer. All full-range models include 70V/100V transformers and low impedance inputs. They deliver high voice intelligibility, wide bandwidth and exceptional uniform coverage.

The Desono EX-S8 is an 8" two-way surface mount loudspeaker that provides detailed voicing with projection. It is an excellent fill or distributed loudspeaker for systems where pristine voice clarity, higher output and more bass is desired.

Designed for easy and fast installation, our innovative, patented ClickMount™ brackets provide installers with two distinct mounting options. The ClickMount pan-tilt bracket provides indexed aiming control and allows for mounting EX Series quickly in either vertical or horizontal orientation without moving the bracket position. The ClickMount U-Bracket is also available for low profile mounting or exterior use and includes the ClickPlug with an integrated gland nut for weather-resistant applications. Both brackets are theft and tamper resistant.

TECHNICAL SPECIFICATIONS

Operating Mode	Passive with selectable low-impedance or 70V/100V operation		
Operating Environment	Indoor/Outdoor		
Operating Range	60 Hz to 20 kHz		
Nominal Beamwidth (H x V)	100°, conical		
Transducers	LF 1 x 8" (203mm) treated paper cone HF 1 x 1.4" (36mm) horn-loaded treated soft dome		
Continuous Power Handling @ Nominal Impedance	Passive	45V	250W @ 8 ohms (1000W peak)
Nominal Sensitivity @ 1m	Passive	@ 1W 91 dB	@ 2.83V 91 dB
Nominal Maximum SPL	Passive	Peak 121 dB	Continuous 115 dB
Transformer	70V: 80W, 40W, 20W, 10W 100V: 80W, 40W, 20W		
Required Accessories	50 Hz, 12dB/Oct High pass filter, DSP		
Recommended Amplifiers	250W - 500W @ 8 ohms (45V-63V)		

PHYSICAL

Input Connection	Lever-actuated wire clamping 4-position terminal block with pass-through
Controls	Wattage / low impedance selector switch
Mounting Provisions	ClickMount pan-tilt bracket <u>or</u> ClickMount U-Bracket
Compliance	ETL listed to comply with UL 1480A, CSA STD C22.2# 62368-1, and CSA STD C22.2# 60950-22 Certified to EN54-24
Environmental Rating	IP54 per IEC 60529
Dimensions H x W x D	17.4" x 10.3" x 10.2" (443mm x 262mm x 260mm)
Weight	TBD
Finish	Refer to the Technical Drawings (page 2)
Models (Order by mounting option)	EX-S8-CM [-B,-W] - loudspeaker with large ClickMount pan-tilt bracket EX-S8-UB [-B,-W] - loudspeaker with ClickMount U-Bracket and ClickPlug

OPTIONS

Accessories	CMX-LG [-B,-W] - Large ClickMount pan-tilt bracket kit EXUB-S8 [-B,-W] - EX-S8 ClickMount U-Bracket kit
-------------	--

Biamp strives to improve its products on a continual basis. Specifications are therefore subject to change without notice.

Data presented on this spec sheet represents the basic performance specifications for the model. For a detailed analysis of this loudspeaker's performance, please download the GLL file and/or the CLF file from our website: biamp.com

DESONO

EX-S8 TWO-WAY COAXIAL 8-INCH SURFACE MOUNT LOUDSPEAKER

EX-S8-CM

EX-S8 Loudspeaker with ClickMount pan-tilt bracket

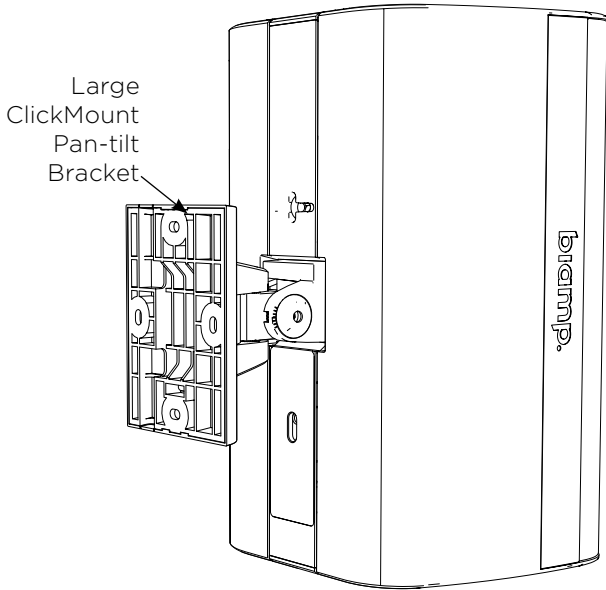

Pivot angle (portrait orientation)
 Horizontal 120° in 10° increments
 Vertical 56° in 8° increments

EX-S8-UB

EX-S8 Loudspeaker with ClickMount U-Bracket and ClickPlug

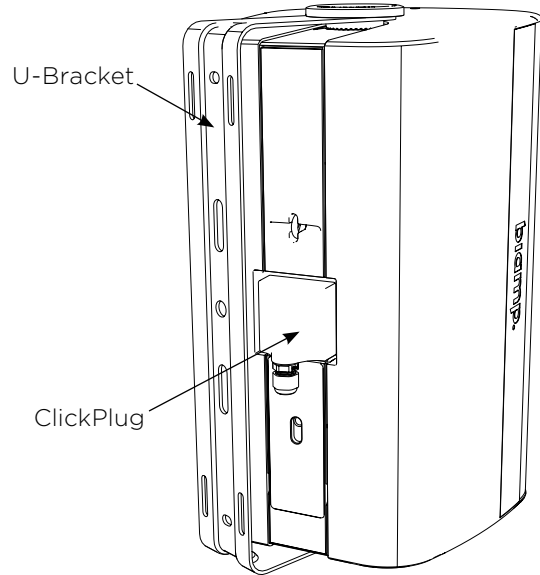

Pivot angle
 200° in 10° increments

TECHNICAL DRAWING / DIMENSIONS / FINISH

H x W x D
 17.4" x 10.3" x 10.2"
 (443mm x 262mm x 260mm)

Unit Weight
 TBD

Shipping Weight
 TBD

Grille
 Powder-coated perforated Marine Grade aluminum backed with hydrophobic cloth
 Black or White

Enclosure / Finish
 UL94 5VB rated ABS plastic, matte finish
 Black or White

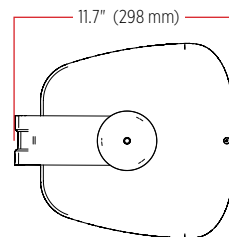

Top (with U-Bracket)

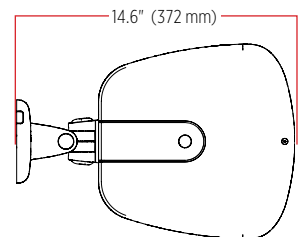

Top (with pan-tilt)

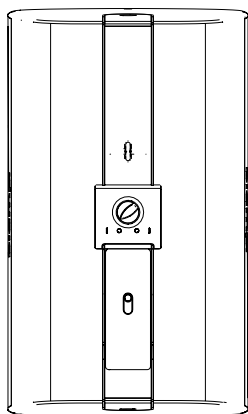

Rear

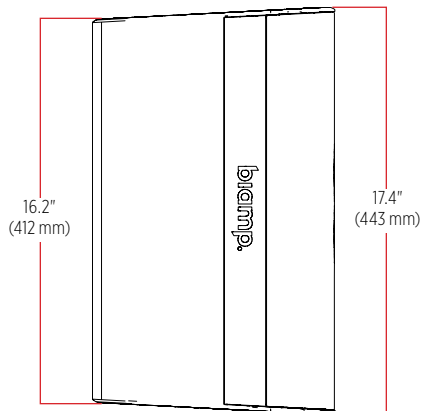

Side

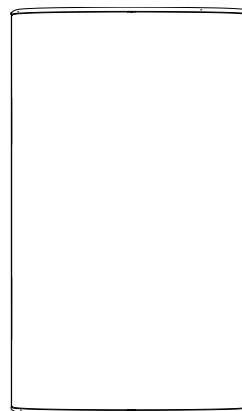

Front

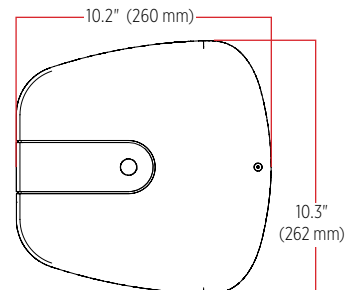

Top

