



DMPS3-4K-200-C/DMPS3-4K-300-C 3-Series[®] 4K DigitalMedia[™] Presentation Systems

Supplemental Guide
Crestron Electronics, Inc.

The product warranty can be found at www.crestron.com/warranty.

The specific patents that cover Crestron products are listed at patents.crestron.com.

Certain Crestron products contain open source software. For specific information, please visit www.crestron.com/opensource.

Crestron, the Crestron logo, .AV Framework, 3-Series, DigitalMedia, and DM 8G+ are either trademarks or registered trademarks of Crestron Electronics, Inc. in the United States and/or other countries. HDBaseT and the HDBaseT Alliance logo are either trademarks or registered trademarks of the HDBaseT Alliance in the United States and/or other countries. HDMI and the HDMI logo are either trademarks or registered trademarks of HDMI Licensing LLC in the United States and/or other countries. Other trademarks, registered trademarks, and trade names may be used in this document to refer to either the entities claiming the marks and names or their products. Crestron disclaims any proprietary interest in the marks and names of others. Crestron is not responsible for errors in typography or photography.

This document was written by the Technical Publications department at Crestron.
©2017 Crestron Electronics, Inc.

Contents

Introduction	1
Using the Front Panel LCD	1
Accessing and Navigating the Setup Menu	2
Accessing the Setup Menu	3
Navigating the Setup Menu	3
Configuring Network Settings.....	4
IP Address	4
Subnet Mask.....	4
Default Router	5
DHCP	5
Hostname	5
Domain Name	6
MAC Address	7
System ID	7
Configuring Control Settings	7
Backlight	8
Password.....	8
Info.....	8
Messages	9
Time/Date	9
Front Panel	10
Using the Routing Push Buttons	11
Routing an Input to Outputs.....	12
Viewing Routing Status	12

DMPS3-4K-200-C/DMPS3-4K-300-C: 3-Series® 4K DigitalMedia™ Presentation Systems

Introduction

The Crestron® DMPS3-4K-200-C and DMPS3-4K-300-C provide high-performance routing of HDMI® and other audio/video sources. The DMPS3-4K-200-C includes six HDMI inputs and one DM 8G+® input. The DMPS3-4K-300-C includes six HDMI inputs and two DM 8G+ inputs. Video outputs consist of one HDMI output and one DM 8G output on the DMPS3-4K-200-C and two HDMI outputs and two DM 8G+ outputs on the DMPS3-4K-300-C. The HDMI outputs on the DMPS3-4K-200-C and DMPS3-4K-300-C provide 4K/60 video scaling.

The DMPS3-4K-200-C and DMPS3-4K-300-C provide the built-in .AV Framework™ setup and management tool, which allows simplified configuration of the devices without the need for SIMPL programming (refer to the .AV Framework™ Software for DMPS3 Operations Guide [Doc. 7887] at <http://www.crestron.com/manuals> for additional information). In addition to providing the .AV Framework setup and management tool, the DMPS3-4K-200-C and DMPS3-4K-300-C can be configured using the web interface, SIMPL Windows, or the front panel LCD (liquid crystal display).

This guide provides information about using the LCD and the routing push buttons on the front panel of the DMPS3-4K-200-C and DMPS3-4K-300-C. For installation information, refer to the DMPS3-4K-200-C/DMPS3-4K-300-C DO Guide (Doc.7791).

Using the Front Panel LCD

When the device is powered on, the front panel LCD provides system bootup status information. When the system bootup process is complete, the LCD indicates the name of the device and the build version as shown in the sample screen below.

DMPS3-4K-300-C Build Ver 1.502.0003
--

The LCD then shows the main DMPS3-4K-200-C or DMPS3-4K-300-C screen, which displays only the name of the device as shown in the sample screen below.

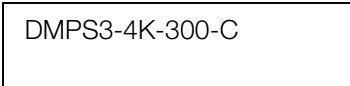

The LCD provides a Setup Menu, which can be accessed once the main DMPS3-4K-200-C or DMPS3-4K-300-C screen appears on the LCD. The Setup Menu allows configuration of DMPS3-4K-200-C and DMPS3-4K-300-C network and control settings. The following illustration provides a menu tree of the Setup Menu.

Setup Menu Tree

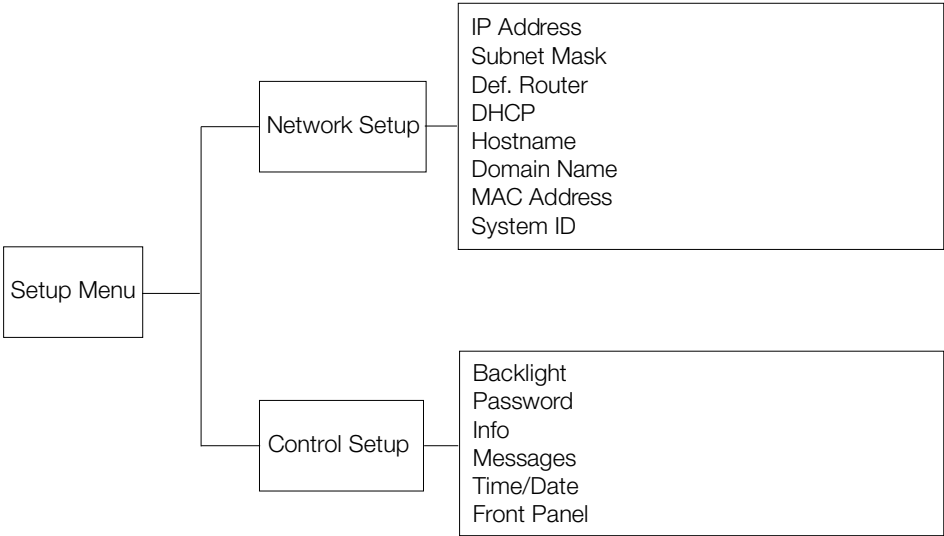

The following sections provide information about the Setup Menu.

Accessing and Navigating the Setup Menu

To access and navigate the Setup Menu, use the soft buttons, menu push buttons, and **VOLUME** control on the front panel of the DMPS3-4K-200-C and DMPS3-4K-300-C.

Soft Buttons, Menu Push Buttons, and VOLUME Control (DMPS3-4K-300-C Shown)

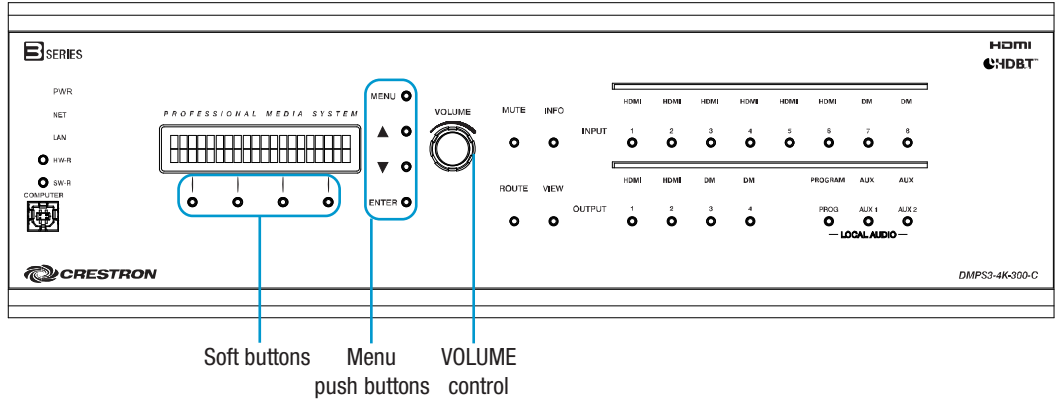

Accessing the Setup Menu

To access the Setup Menu, do the following:

1. Press the **MENU** button. The **Enter Password** prompt appears on the LCD.

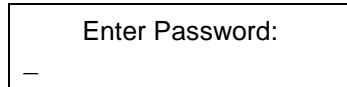

Enter Password:
_

2. Using the **VOLUME** control, enter the digits in the password. To move the cursor to the right when entering the digits, press the **▲** button as appropriate. To move the cursor to the left (if necessary), press the **▼** button. The default password is **12345**.
3. Press **ENTER** to apply the password.

The Setup Menu opens.



Setup Menu
Network Setup ▼

Navigating the Setup Menu

To navigate the Setup Menu and submenus, do the following:

- To navigate upward in a menu or to move the cursor to the right when entering data, press the **▲** button.
- To navigate downward in a menu or to move the cursor to the left when entering data, press the **▼** button.
- To select an item in a menu or to apply a new setting, press the **ENTER** button.
- To go back to the previous level in a menu, press the **MENU** button.
- To select an item in a series of items displayed horizontally on the LCD, press the soft button under the desired item.
- To enter digits or uppercase and lowercase letters, turn the **VOLUME** control knob clockwise or counterclockwise, or use the **▲** and **▼** buttons as applicable until the desired character is displayed.

To exit the Setup Menu, do the following:

1. Press the **MENU** button until the **Exit Setup Menu** prompt appears on the LCD.

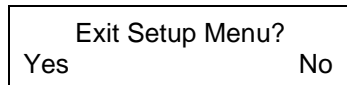

Exit Setup Menu?
Yes No

2. Press the soft button under the **Yes** option. The LCD returns to the main DMPS3-4K-200-C or DMPS3-4K-300-C screen.

Configuring Network Settings

To configure network settings, do the following: On the Setup Menu, select **Network Setup**. The Network Setup menu opens.

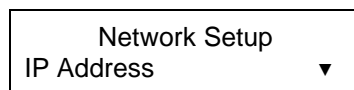

Available selections are as follows:

- IP Address
- Subnet Mask
- Def. Router
- DHCP
- Hostname
- Domain Name
- MAC Address
- System ID

Each of the items on the Network Setup menu is discussed below.

IP Address

By default, DHCP is enabled. To view the current IP address or to set a static IP address, do the following:

NOTE: To be able to set a static IP address, DHCP (Dynamic Host Configuration Protocol) must be set to **Off**. For additional information, refer to "DHCP" on page 5.

1. On the Network Setup menu, select **IP Address**. The current IP address appears on the LCD.

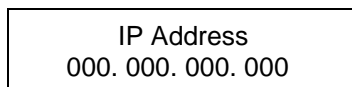

If DHCP is set to **Off**, continue with step 2 to set a static IP address.

2. Using the appropriate soft button under each octet in the IP address, select an octet and then use the **VOLUME** control or the **▲** and **▼** buttons until the desired setting appears in the octet.
3. Press **ENTER** to apply the IP address.

Subnet Mask

To view or set a subnet mask, do the following:

NOTE: To be able to set a subnet mask, DHCP must be set to **Off**. For additional information, refer to "DHCP" on page 5.

1. On the Network Setup menu, select **Subnet Mask**. The current subnet mask appears on the LCD.

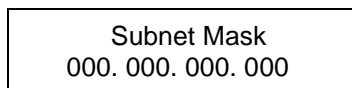

If DHCP is set to **Off**, continue with step 2 to set a subnet mask.

- Using the appropriate soft button under each octet in the subnet mask, select an octet and then use the **VOLUME** control or the ▲ and ▼ buttons until the desired setting appears in the octet.
- Press **ENTER** to apply the subnet mask.

Default Router

To view or set a default router IP address, do the following:

NOTE: To be able to set a default router IP address, DHCP must be set to **Off**. For additional information, refer to "DHCP" below.

- On the Network Setup menu, select **Def. Router**. The current default router IP address appears on the LCD.

Def. Router
000.000.000.000

If DHCP is set to **Off**, continue with step 2 to set a default router IP address.

- Using the appropriate soft button under each octet in the default router IP address, select an octet and then use the **VOLUME** control or the ▲ and ▼ buttons until the desired setting appears in the octet.
- Press **ENTER** to apply the default router IP address.

DHCP

DHCP is enabled by default. To enable or disable DHCP, do the following:

- On the Network Setup menu, select **DHCP**. The DHCP screen appears on the LCD.

DHCP
*On ▼

- Do either of the following:
 - To enable DHCP, select **On** (default setting).
 - To disable DHCP, select **Off**.
- Press **ENTER** to apply the setting. An asterisk precedes the selected setting.

Hostname

To view or set the hostname, do the following:

- On the Network Setup menu, select **Hostname**. The current hostname appears on the display. The default hostname is DMPS3-xxxxxxx (xxxxxxx consists of the last eight characters [excluding punctuation] of the MAC address). The MAC address is labeled on the rear panel of the device.

Hostname
DMPS3-7F8B1E9C

- Press **ENTER** to change the hostname. A screen appears allowing the hostname to be changed.

```
DMPS3-7F8B1E9C
DEL  INS  <  >
```

3. Enter the desired hostname by doing any of the following:

NOTE: The maximum numbers of characters in a hostname is 15. The hostname can consist of digits, uppercase and lowercase letters, and a hyphen (-).

- To enter the characters in a hostname, use the ▲ and ▼ buttons.
 - To move the cursor to the left, press the soft button under the < symbol.
 - To move the cursor to the right, press the soft button under the > symbol.
 - To delete a character, position the cursor under the character to be deleted and then press the soft button under **DEL**.
 - To insert a space, position the cursor where the space is to be inserted and then press the soft button under **INS**.
4. Press **ENTER** to apply the hostname.

Domain Name

To view or set the domain name, do the following:

1. On the Network Setup menu, select **Domain Name**. If a domain name exists, the name appears on the LCD. If a domain name does not exist, the word **CLEAR** appears on the LCD.

```
Domain Name
CRESTRON.CRESTRON.C
```

2. Press **ENTER** to change the domain name. A screen appears allowing the domain name to be changed.

```
CRESTRON.CRESTRON.C
DEL  INS  <  >
```

3. Enter the desired domain name by doing any of the following:
 - To enter digits and uppercase and lowercase letters, use the ▲ and ▼ buttons.
 - To move the cursor to the left, press the soft button under the < symbol.
 - To move the cursor to the right, press the soft button under the > symbol.
 - To delete a character, position the cursor under the character to be deleted and then press the soft button under **DEL**.
 - To insert a space, position the cursor where the space is to be inserted and then press the soft button under **INS**.

MAC Address

The LCD displays the MAC address. To view the MAC address, do the following: On the Network Setup menu, select **MAC Address**. A screen appears displaying the MAC address as shown in the sample below.

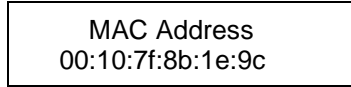

System ID

NOTE: The default system ID number is 1. It is recommended that the system ID always be changed to a number other than 1.

NOTE: A unique system ID must be assigned to the DMPS3-4K-200-C or DMPS3-4K-300-C whenever the device connects to the DM 8G+ input or DM 8G+ output of another DMPS3 series or DM-MD series switcher.

To set a unique system ID, do the following:

1. On the Network Setup menu, select **System ID: x** (x is the current ID number). The current system ID number appears on the display.

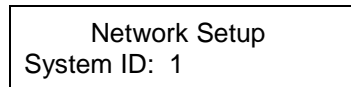

2. Press **ENTER** to set a unique system ID number. A screen appears allowing the system ID to be changed.

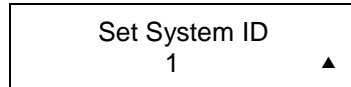

3. Using the **▲** or **▼** button, select a unique system ID number.
4. Press **ENTER** to apply the system ID number.

Configuring Control Settings

To configure control settings, do the following: On the Setup Menu, select **Control Setup**. The Control Setup menu opens.

Control Setup Menu

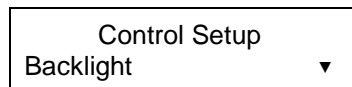

Available selections are as follows:

- Backlight
- Password
- Info
- Messages
- Time/Date
- Front Panel

Each of the items on the Control Setup menu is discussed below.

Backlight

The backlight of the LCD can be changed. To change the backlight setting, do the following:

1. On the Control Setup menu, select **Backlight**. A screen appears allowing the desired brightness to be set.

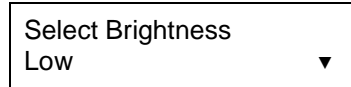

2. Using the ▲ or ▼ button, select one of the following options: **Low**, **Medium**, or **High**. The default setting is **Medium**.
3. Press **ENTER** to apply the selected setting. An asterisk precedes the selected setting.

Password

To change the password, do the following:

1. On the Control Setup menu, select **Password**. A screen appears allowing the password to be changed.

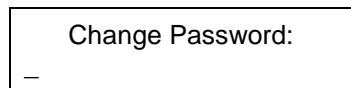

The password can consist of up to five digits ranging from **0** to **9**.

2. Using the **VOLUME** control, enter the desired digits. To move the cursor to the right when entering the digits, press the ▲ button as appropriate. To move the cursor to the left (if necessary), press the ▼ button.
3. Press **ENTER** to apply the password.

Info

Program, hardware, network, and operating system Information about the DMPS3-4K-200-C and DMPS3-4K-300-C can be viewed. To view the information, do the following:

1. On the Control Setup menu, select **Info**. The Info screen appears.

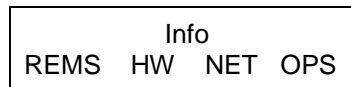

2. Do any of the following:
 - To view program information, press the soft button under **REMS**.
 - To view hardware information, press the soft button under **HW**.
 - To view a list of connected network devices, press the soft button under **NET**.
 - To view operating system information, press the soft button under **OPS**.

If partial information is displayed, press the soft button under the >> symbol to scroll to the right. To scroll to the left, press the soft button under the << symbol.

To view all available items listed under **REMS**, **HD**, **NET**, or **OPS**, press the ▼ or ▲ button as appropriate.

Messages

System messages are stored in a message log. To view system messages, do the following:

1. On the Control Setup menu, select **Messages**. The SYSTEM LOG screen appears.

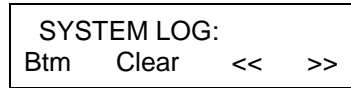

2. Do any of the following:
 - To view messages in the log, press the ▼ or ▲ button as appropriate. To view the entire contents of the message, press the soft button under the >> symbol to scroll to the right. To scroll to the left, press the soft button under the << symbol.
 - To go to the end of the system log, press the soft button under **Btm** (bottom).
 - To go to the beginning of the system log, press the soft button under **Top** (not shown in the screen above).
 - To erase all messages in the log, press the soft button under **Clear**.

Time/Date

To set a time and date, do the following:

1. On the Control Setup menu, select **Time/Date**. A screen appears displaying a date and time.

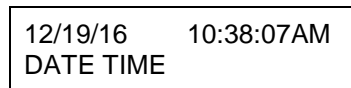

2. To set the date, do the following:
 - a. Press the soft button under **DATE**. A screen appears displaying a date.

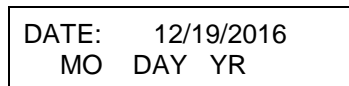

- b. Do the following:
 - i. To set the month, press the soft button under **MO**. Brackets enclose the month that is displayed. Use the ▲ or ▼ button to select the desired month.
 - ii. To set the day, press the soft button under **DAY**. Brackets enclose the day that is displayed. Use the ▲ or ▼ button to select the desired day.
 - iii. To set the year, press the soft button under **YR**. Brackets enclose the year that is displayed. Use the ▲ or ▼ button to select the desired year.
 - iv. Press **ENTER** to apply the settings.

3. To set the time, do the following:
 - a. Press the soft button under **TIME**. A screen appears displaying the time.

TIME:	10/38/07AM	
HR	MIN	AM/PM

- b. Do the following:
 - i. To set the hour, press the soft button under **HR**. Brackets enclose the hour that is displayed. Use the ▲ or ▼ button to select the desired hour.
 - ii. To set the minutes, press the soft button under **MIN**. Brackets enclose the minutes that are displayed. Use the ▲ or ▼ button to select the desired minutes.
 - iii. To set either **AM** or **PM**, press the soft button under **AM/PM**. Brackets enclose **AM** or **PM**. Use the ▲ or ▼ button to select **AM** or **PM**.
 - iv. Press **ENTER** to apply the settings.

Front Panel

By default, the front panel **VOLUME** control and the **MUTE**, **INFO**, **ROUTE**, **VIEW**, **INPUT**, **OUTPUT**, and **LOCAL AUDIO** buttons are enabled, allowing operational changes to be made. The front panel controls can be disabled.

NOTE: When the **VOLUME** control and the **MUTE**, **INFO**, **ROUTE**, **VIEW**, **INPUT**, **OUTPUT**, and **LOCAL AUDIO** buttons are disabled, the **MENU**, ▼, ▲, **ENTER**, and soft buttons remain enabled.

To enable or disable the front panel controls, do the following:

1. On the Control Setup menu, select **Front Panel**. A screen appears allowing the front panel controls to be locked (disabled) or unlocked (enabled).

Front Panel Lock: On

2. Do either of the following:
 - To enable the front panel controls, select **On** (default setting).
 - To disable the front panel controls, select **Off**.
3. Press **ENTER** to apply the setting. An asterisk precedes the selected setting.

Using the Routing Push Buttons

The DMPS3-4K-200-C and DMPS3-4K-300-C provide routing push buttons that can be used to route inputs to outputs. Routing LEDs indicate the routing status.

NOTE: If the front panel controls are disabled, pressing the routing push buttons has no effect (refer to "Front Panel" on page 10).

The DMPS3-4K-200-C provides a **ROUTE** push button, a **VIEW** push button, seven **INPUT** push buttons, five **OUTPUT** push buttons, and corresponding LEDs as shown in the illustration below.

Routing Push Buttons and LEDs on the DMPS3-4K-200-C

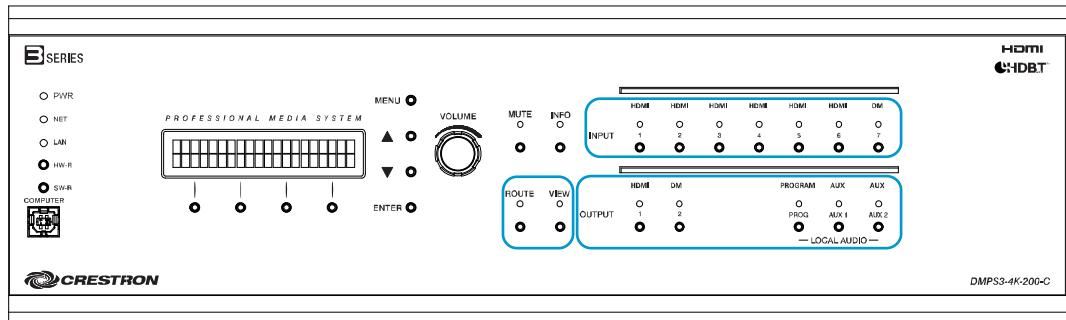

The **INPUT** push buttons consist of the following:

- Six **HDMI** push buttons numbered 1–6
- One **DM** push button numbered 7

The **OUTPUT** push buttons consist of the following:

- One **HDMI** push button numbered 1
- One **DM** push button numbered 2
- Three **LOCAL AUDIO** push buttons labeled **PROG**, **AUX 1**, and **AUX 2**

The DMPS3-4K-300-C provides a **ROUTE** push button, a **VIEW** push button, eight **INPUT** push buttons, seven **OUTPUT** push buttons, and corresponding LEDs as shown in the illustration below.

Routing Push Buttons and LEDs on the DMPS3-4K-300-C

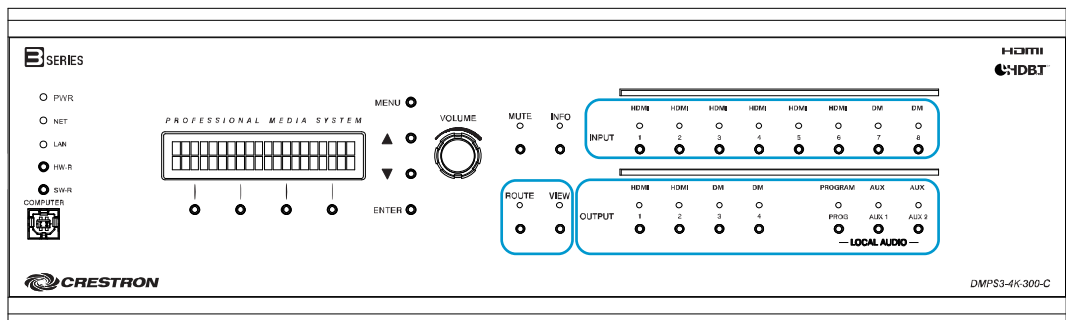

The **INPUT** push buttons consist of the following:

- Six **HDMI** push buttons numbered 1–6
- Two **DM** push buttons numbered 7 and 8

The **OUTPUT** push buttons consist of the following:

- Two **HDMI** push buttons numbered 1 and 2
- Two **DM** push buttons numbered 3 and 4
- Three **LOCAL AUDIO** push buttons labeled **PROG**, **AUX 1**, and **AUX 2**

The following sections provide information about routing an input to outputs and about viewing routing status.

Routing an Input to Outputs

To route an input to one or more outputs on the DMPS3-4K-200-C or DMPS3-4K-300-C, do the following:

1. Press the **ROUTE** push button. The **ROUTE** LED and the **OUTPUT** LEDs of any unrouted outputs light solid red.
2. Press the **INPUT** push button that corresponds to the input to be routed. The corresponding **INPUT** LED lights solid red to indicate that the input is selected, and the **OUTPUT** LEDs of the unrouted outputs turn off.
3. Press the desired **OUTPUT** push buttons. The **OUTPUT** LEDs of the selected outputs blink red.
4. Press **ENTER** to apply the route. The **ROUTE** and **INPUT** LEDs remain solid red, and the **OUTPUT** LEDs of the selected outputs light solid red.

Viewing Routing Status

To view information about a route, do the following:

1. Press the **VIEW** button.
2. Press the desired **OUTPUT** button.

The LCD displays the number of the selected output and the number of the input that is being routed to the selected output.

This page is intentionally left blank.

Crestron Electronics, Inc.
15 Volvo Drive Rockleigh, NJ 07647
Tel: 888.CRESTRON
Fax: 201.767.7576
www.crestron.com



Supplemental Guide – DOC. 7849A
(2047259)
01.17
Specifications subject to
change without notice.